



DVD/CD/CD-R/CD-RW PLAYER
DVD 1046
USER MANUAL



Please read this User Manual carefully to ensure proper use of this product and keep this manual for future reference.

EMPOF

SAFETY INSTR



preser
within
suffici
shock

/head
triangle
to the
voltage
may of
a risk of electric

ope
instr
apl

it within a...
is intended to alert
presence of important
(servicing)
accompanying the

1.
of
p

S - All the safety and
could be read before the

2.
of

UTIONS - The safety and
ns should be retained for futur

INGS - All warnings on the
ne operating instructions

INSTRUCTIONS - All
ions should be foll

ING - Unplug this
fore cleaning. D
sol cleaners. U
leaning.

TACHMENT
mmended b
y cause he

. WATER
product
wash
bas
8
ES - Do not place
cart hand, trip
product may fall,
admit, and
damage to the product.

should follow...
should use a mounting accessory recommended by
the manufacturer.
A Product and Cart Combination S
with Care - Quick stops, excess
surfaces may cause the prod
to overturn.

9. VENTILATION - Slots and opening
are provid
operati
overh
or
sofa, rug or other
could not be placed in
ch and a bookcase or rack,
ion is provided or the
structions have been adhered to.

SOURCES - This product should be
only from the type of power source
ed on the marking label. If you are not
e type of power supply to your home, consult
our product dealer or local power company. For
products intended to operate on battery power,
or other sources, refer to the operating instructions

11. GROUNDS OR POLARIZATION
product may be equipped with a n
alt (narrower than the other) T
t only one w
able to in
ever
to fit,
your obsolete outlet.
pose of the polarized plug

CORD PROTECTION
should be routed so that
walked on or pinched
them, paying
can

IMPORTANT SAFETY INSTRUCTIONS

13. NONUSE PERIODS - The power cord of the product should be unplugged from the outlet when left unused for long periods of time.

14. OUTDOOR ANTENNA GROUNDING - If an outside antenna or cable system is connected to the product, be sure the antenna or cable system is grounded so as to provide some protection against voltage surges and built-up static charges. Article 810 of the National Electrical Code, ANSI/NFPA 70, provides information with regard to proper grounding of the mast and supporting structure, grounding of the lead-in wire to an antenna discharge unit, size of grounding conductors, location of antenna-discharge unit, connection to grounding electrodes, and requirements for the grounding electrode. See Figure 1.

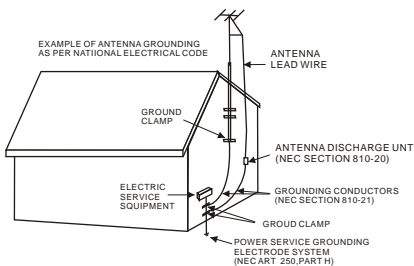

15. LIGHTNING - For added protection for this product during a lightning storm, or when it is left unattended and unused for long periods of time, unplug it from the wall outlet and disconnect the antenna or cable system. This will prevent damage to the product due to lightning and power-line surges.

16. POWER LINES - An outside antenna system should not be located in the vicinity of overhead power lines or other electric light or power circuits, or where it can fall into such power lines or other electric light or power circuits. When installing an outside antenna system, extreme care should be taken to keep from touching power lines or circuits as contact with them might be fatal.

17. OVERLOADING - Do not overload wall outlets, extension cords, or integral convenience receptacles as this can result in a risk of fire or electric shock.

18. OBJECT AND LIQUID ENTRY - Never push objects of any kind into this product through openings as they may touch dangerous voltage points or short-out parts that could result in a fire or electric shock. Never spill liquid of any kind on the product.

19. SERVICING - Do not attempt to service this product yourself as opening or removing covers may expose you to dangerous voltage or other hazards. Refer all servicing to qualified service personnel.

20. DAMAGES REQUIRING SERVICE -

Unplug this product from the wall outlet and refer servicing to qualified service personnel under the following conditions.

- When the power-supply cord or plug is damaged.
- If liquid has been spilled, or objects have fallen into the product.
- If the product has been exposed to rain or water.
- If the product does not operate normally by following the operating instructions. Adjust only those controls that are covered by the operating instructions as an improving adjustment of other controls may result in damage and will often require extensive work by a qualified technician to restore the product to its normal operation.
- When the product exhibits a distinct change in performance - this indicates a need for service.

21. REPLACEMENT PARTS - When replacement parts are required, be sure the service technician has used replacement parts specified by the manufacturer or have the same characteristics as the original part. Unauthorized substitutions may result in fire, electric shock or other hazards.

22. SAFETY CHECK - Upon completion of any service or repair to this product, ask the service technician to perform safety checks to determine that the product is in proper operating condition.

23. HEAT - The product should be situated away from heat sources such as radiators, heat registers, stoves or other products (including amplifiers) that produce heat.

IMPORTANT SAFETY INSTRUCTIONS

To protect intellectual property, the involved organizations partition the world into six regions, each of which can only use the DVD player and DVD disc with the given regional code.

The illustration on the right shows symbols of the six regions. One DVD player with a given regional code cannot play disc of another regional code. The partition of regional codes is shown as follows:

1. Canada, USA;
2. Japan, Europe, South Africa, Middle East
3. Southeast Asia, East Asia
4. Australia, New Zealand, Oceania, Central America, Mexico, Latin America, Caribbean Sea;
5. Russia, India, Africa, Korea, Mongolia.
6. China.







Note: THE REGION CODE FOR THE UNIT IS 1.





TV connections for DVD discs recorded in PAL and NTSC systems

Generally, DVD discs are recorded in PAL or NTSC systems, please refer to the following table:





■ Connecting to the multi-system TV

DISC	TV MONITOR
 PAL	 Play in PAL system
 NTSC	 Play in NTSC system

■ Connecting to NTSC TV

DISC	TV MONITOR
 PAL	 No clear images are shown on the screen.
 NTSC	 Play in NTSC system

■ Connecting to PAL TV

DISC	TV MONITOR
 PAL	 Play in PAL system
 NTSC	 No clear images are shown on the screen.

Please read the user manual carefully before connection or operation

TABLE OF CONTENT

Important Safety	1
Features	5
Precautions	5
Accessories	6
Front Panel	6
Rear Panel	6
Remote Control	7
Basic Connection	8
Remote Control Preparation	10
Operations	11
Preparation	11
Play	11
Stop	11
Prev/Next	11
FB/FF	11
Slow	11
Step	11
Pause	11
Number(0-9,10+) button	11
Mute	12
VOL+/VOL-	12
Return	12
OSD	12
Zoom	12
A-B Repeat	12
Repeat	12
Angle/Audio	12
Program	12
PBC	12
GO TO	13
Title/Chapter search	13
Menu	13
Subtitle	13
Clear	13
N/P	13
Setup	14
Reference(Menu/Submenu/Options)	15
Handling Precautions	16
player Maintenance	16
Definition of terms	17
Specifications	17
Troubleshooting	18

FEATURES

DVD - A completely new dimension in video entertainment

- Subtitles may be displayed in one of a maximum of 32 languages available (multi-subtitles DVD only).
- Audio soundtrack can be heard in up to 8 languages (multi-languages DVD only).
- Multi-angle function allows you to choose the viewing angles of scene (for DVD with multiple camera angles only).

Other convenient features

- Parental lock settings to prevent playing unsuitable discs for some audiences (DVD only). A full function remote control provides quick access to DVD functions.

Compatible with PAL DVD and NTSC DVD

- This player can play discs recorded in either PAL or NTSC system.

Compatible with CD besides DVD, MP3, CD-R

- This player could play various discs such as DVD, CD (8cm/12cm discs).

PRECAUTIONS

- Please read these precautions before operating this unit.

Power cord protection

- To avoid any malfunctions of the unit, and to protect against electric shock, fire or personal injury, please observe the following.
- Hold the plug firmly when connecting or disconnecting the AC power cord to this unit.
- Do not connect or disconnect the AC power cord when your hands are wet.
- Keep the AC power cord away from heating appliances.
- Never put any heavy object on the AC power cord.
- Do not attempt to repair or reconstruct the AC power cord.
- Remove dust, dirt etc. on the plug regularly.
- If the unit has been dropped or otherwise damaged, turn off the power and disconnect the AC power cord.
- If you find smoke, unusual odour or noise from the unit, turn off the power and disconnect the AC power cord.

Placement

The internal parts may be seriously damaged if the unit is placed in areas of:

- Direct sunlight or heating radiators or closed automobiles;
- High temperature (over 35°C) or high humidity (over 90%)
- Excessive dust;
- Strong magnetic or static electricity;
- Vibration, impact or where the surface is tilted.

Non-use Periods

- Turn off the power when the unit is not used.
- It should be unplugged when the unit is idle for a long period of time.

No fingers or other objects inside

- Touching internal parts of this unit is dangerous, and may cause serious damage to the unit and even human injury.
- Do not try to disassemble this unit.
- Do not put any other object on the disc tray.

Keep away from water and magnets

- Keep the unit away from flower vases, tubs, sinks, etc. If liquids are spilled into the unit, serious damage could occur.
- Never place magnetic objects such as speakers near the unit.

Stacking

- Place the unit in a horizontal position and do not place anything heavy on it.
- Do not put the unit on amplifiers or other equipment.

Condensation

Moisture may form on the lens under the following conditions:

- In a steamy or very humid room.
- Immediately after a heater is turned on.
- If moisture forms inside this unit, it may not operate properly. In this case, turn on the power and wait for about 1 hour to evaporate it.

Interference for the TV broadcast

- Depending on the reception condition of the TV, interference may appear on the TV screen while you are watching a TV broadcast and the unit is turned on. This is not a malfunction of the unit of the TV. Just ensure that the unit is turned off when you watch a TV broadcast.



REMOTE CONTROL

1. OPEN/CLOSE button
2. Program button
3. Mute button
4. Audiobutton
5. Subtitle button
6. Zoom button
7. A-Bbutton
8. OSD button
9. Menu button
10. VOL+ button
11. Slowbutton
12. VOL- button
13. L/R button
14. Enter button
15. Play button
16. Titlebutton
17. Pause button
18. Fast reversebutton
19. Fast forwardbutton
20. Prev button
21. Next button
22. N/P button
23. PBC button
24. Stop button
25. ◀▶▼▲ button
26. Setup button
27. Angle button
28. Clear button
29. Return button
30. Repeat button
31. Number (0-9)button
32. GO TO button
33. Step button
34. Power button

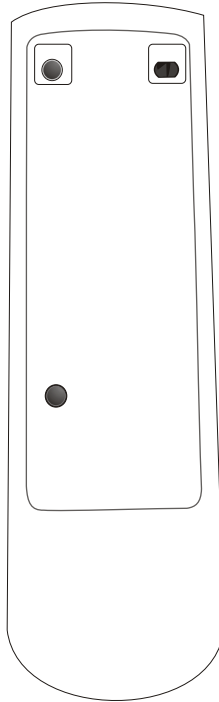

Note:

The same buttons on remote control and front panel have identical functions.

BASIC CONNECTION

- Ensure that the power switch of this unit and other equipment to be connected is turned off before commencing connection.
- Read through the instructions before connecting other equipment.
- Ensure that you observe the colour-coding when connecting audio and video cords.

A: Connecting to a stereo TV set

1. TV set (optional)
2. DVD/CD player
3. Connecting Video, R/L audiocords
4. To TV set audio input connector
5. AC power cord

To get the best viewing quality you are advised to use S-video cord to connect the TV set with S-video input and to change the TV set to S-video input mode.

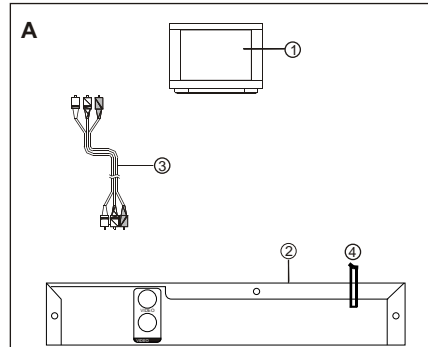

B: Connection to monophonic TV

1. TV set (optional)
2. DVD/CD player
3. Connecting L/R audio cords
4. To TV set audio input connector
5. Component connector cord (video)

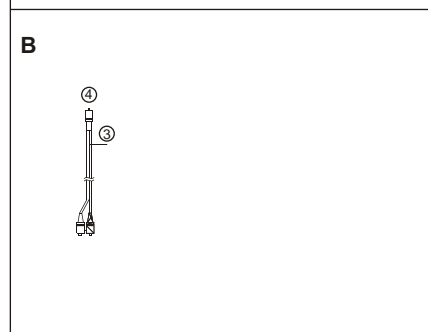

C: Connection to audio equipment

1. Audioplayer (optional)
2. TV set (optional)
3. DVD/CD players
4. To TV video input connector (yellow)
5. To audio input connectors (red, white)
6. To TV S-video input connector

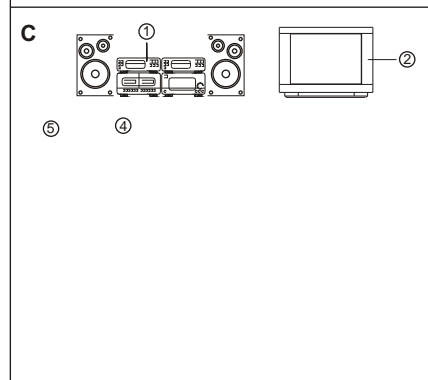

BASIC CONNECTION

D: Connecting to AV amplifier with 2-channel input connector

1. TV set (optional)
2. DVD / CD player
3. Video / S-video cord (optional)
4. Amplifier with 2 channel input jacks
5. To audio input connector (L,R)
6. Left speaker
7. Right speaker

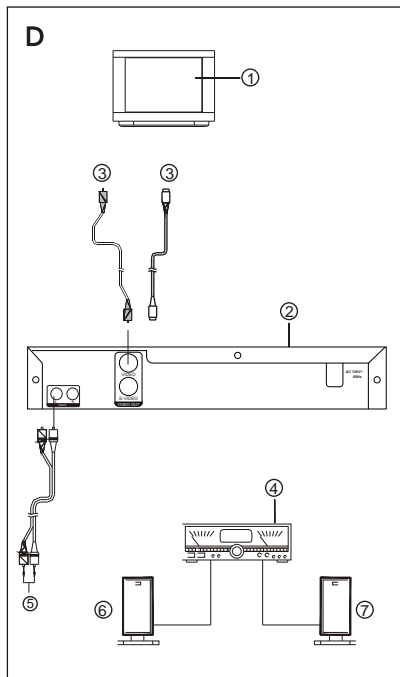

OPERATION

PREPARATION BEFORE PLAYING DISC

- The option of display language catalogue is preset to English. Please refer to Setup operation
- Most functions are operated by remote control. Either operation of remote control of front panel is effective when their buttons indicate the same function.

Preparation

- Turn the TV on and select AV as the TV input.
- Switch on the related system power if the player has been connected to amplifier equipment etc.

◆ PLAY

1. Connect AC power cord to AC outlet.
 2. Switch on the power, the displayed LOADING indicates the normal power supply. (Note: the disc information appears after several seconds if there has disc after LOADING displayed otherwise appears NO DISC).
 3. Press OPEN/CLOSE.
 4. Place a disc (8cm or 12cm) onto the tray. (For one-sided disc, position it with printed title side facing up. For two-sided disc, position side to be playback facing down).
 5. Press OPEN/CLOSE again to close disc tray.
 6. Press PLAY to playback disc. You may operate according to MENU indication after MENU shows on screen then press ENTER button to play back.
- Some discs may play automatically after loaded.

◆ STOP

Press STOP button to stop playing (TV show "PRESTOP"). When playback is stopped the unit records the point where STOP was pressed (resume function). Press PLAY again, and play will resume from this point. Press STOP button twice, resume function will be cancelled. Resume function is suitable for discs showing playing time during playback.

◆ PREV/NEXT

Press PREV button or NEXT button on remote control when playing a disc, a chapter (DVD) or a track (CD) is skipped backward or forward correspondingly each time the button is pressed.

◆ FB/FF

Press FB/FF button on the remote control during playback, the disc will be played in a status of forward or reverse correspondingly. Forward or Reverse speed is relatively slow at first. When press again, the speed becomes faster. The more times that you press the buttons, the faster the Fast forward or reverse speed will be. There are 5 levels of speed available: X2, X4, X8, X16 and X32. To return to normal play, press PLAY button on the player or the remote control.

Note: Some discs including MP3 disc have no such function.

◆ SLOW

Press SLOW button on the remote control during playback and the unit will enter slow forward status. There are 5 speeds available: 1/2, 1/4, 1/8, 1/16 and 1/32. To return to normal play, press PLAY button on player or remote control again.

Note: Some discs including MP3 disc have no such function.

◆ STEP

Press STEP button during play, the player will enter the still picture mode. If the button is pressed again, the disc is advanced by one frame (step). When the button is kept pressed, consecutive frame advance works. To return to normal play, press PLAY button.

Note: Some discs do not have such function.

◆ PAUSE

Press PAUSE key to stop playing and restore play by pressing PLAY key again.

◆ Number (0-9, 10+) button

By pressing the Number (0-9) button, you can access directly to the desired track or chapters while a disc is played. For track or chapter over 10, press 10+ and then 0-9 button.

OPERATION

◆ MUTE

Press MUTE button during play, the player shows mute and there is no audio output (silence), press again to cancel MUTE.

◆ VOL+/VOL-

Press VOL+/VOL- button play may change volume for audio output.

◆ RETURN

For VCD when playing 2.0 PBC is operating. Press RETURN key, it will return to menu mode. When playing DVD/MP3/JPG discs. Press RETURN key, it will return to menu mode.

◆ OSD

Press OSD button during play to show the disc's relevant information on TV screen (such as playing time, chapter number, playback status).

◆ ZOOM

Zoom function can only be operated in JPEG disc and VCD/DVD format disc. By pressing zoom button when playing DVD/VCD discs, there are 3 levels of zoom available (ZOOMx2, ZOOMx4, ZOOMx1). When playing JPEG disc, there are 5 levels of zoom available (150%, 200%, 25%, 50%, 100%).

Note: Note: Zoom function is not working on PAL system DVDs.

MP3 does not have this function

◆ A-B REPEAT

Press A-B button during playback at the point where repeat play is to commence (a) then press again at the point where repeat play is to be concluded (B). Repeat playback between point (A) and point (B) starts. Press A-B button once more where TV screen appears REP OFF to return to normal play.

◆ REPEAT

Press the repeat key to choose repeat play chapter or title (DVD) and play single audio or full disc (VCD, CD, MP3).

Note: Some VCD do not have repeat function with PBC ON state.

◆ ANGLE/AUDIO

Press ANGLE continuously during playback DVD disc to toggle the disc between available angles recorded on the disc if the disc has multi-angle function. Press AUDIO button during playback to toggle between available audio language recorded on the disc if the disc has this multi-language.

Note: Press AUDIO button could toggle available audio language soundtracks.

◆ PROGRAM

Press PROGRAM button, the program playback screen appears on the TV monitor, 20 tracks or chapters can be programmed. Use $\uparrow \downarrow \leftarrow \rightarrow$ button on the remote control to select your preferred track (CD/VCD) or title and chapter (DVD), then press ENTER button to confirm (also you can press the number button to input the track number or title/chapter number directly).

Note: It is invalid to input the number larger than available. Use CLEAR button to amend false or unsatisfied settings. You can only press the PLAY button on the remote control to start playing after you finish the program setting. Press the PROGRAM button directly to return to normal play mode. In this case, the program is not confirmed.

" $\uparrow \downarrow \leftarrow \rightarrow$: SELECT ▶ : PLAY" shown on screen is only used for indication, no function for cursor.

◆ PBC function (only VCD)

When playing VCD 2.0 press PBC button to display title menu use number key choice and ENTER button to play music.

OPERATION

◆ GO TO

In the play, you press GO TO button on the remote control. You can search the disc based on its title/ chapter/track as shown in the figure. Press GO TO button, a search menu will display. Use ◀ or ▶ button to select the search item/time/titel/chapter. The selected will be shown in highlight.

Use number button to select the search item/time/title/chapter, and press ENTER button to play. For example:

- Time search: To search 16 min 50 secretary: input 1,6,5 and 0.

To search 1 hr 14 min: input 1,1,4,0,0.

- Title/chapter search:

To search titel 1/chapter 2: input 1 in the highlight titel column, move the cursor right to the highlight area and input 2.

Note:

- For some DVD discs which cannot be searched, invalid will be appear on TV screen.
- Input the time, title and chapter of the disc to search.
- For VCD in PBC mode is ON, it can only search for the time.

◆ MENU

Press MENU button on remote control when playing a disc, a list of titles on the disc (depends on discs) will be displayed on TV monitor. Use the direction or number button to select your preferred items then press ENTER button to play as selected.

◆ SUBTITLE

Press SUBTITLE button on remote control during playback. Subtitle: [1] will be displayed on TV monitor that means a kind of language. Press once more, Subtitle: [2] appeared on TV monitor means another kind of language and accordingly subtitles appear that represents how many kinds of language being selected. Subtitle: [OFF] appears that toggle subtitle.

Note: This function is valid only for DVD discs with subtitle function. It is invalid for DVD disc with single subtitle function.

◆ CLEAR

This function is only available in program input mode.

◆ N/P

Press N/P button during stop state can switch output signal to NTSC, PAL or AUTO. The default setting is NTSC.

SETUP

◆ SETUP

Once the initial settings have been completed, the player can always be operated under the same conditions (especially with DVD discs). The settings will be retained in the memory even after turning off the power until the settings are changed. We set the initial language to English when the player is out of factory. You may change the language into that you preferred.

Operation

1. In stop mode, Press SETUP button to enter setup interface as followed, you can setup Language, Screen, Custom.



2. Press ◀ and ▶ to choose the desired section and ENTER button to enter submenu or press SETUP to leave the setup screen. Following is the language setup screen for your reference where you can set OSD menu, DVD menu, Audio Language and Subtitle Language.



REFERENCE

◆ Menu, Submenu and Options

MENU	SUBMENU	OPTIONS	DESCRIPTION
LANGUAGE	OSD	English	English On Screen Display
		French	French On Screen Display
		Geman	Geman On Screen Display
		Italian	Italian On Screen Display
		Spanish	Spanish On Screen Display
	MENU	English	English On Screen Display
		French	French On Screen Display
		Geman	Geman On Screen Display
		Italian	Italian On Screen Display
		Spanish	Spanish On Screen Display
		others	
	Audio	English	English On Screen Display
		French	French On Screen Display
		Geman	Geman On Screen Display
		Italian	Italian On Screen Display
		Spanish	Spanish On Screen Display
		others	
	Subtitle	English	English On Screen Display
		French	French On Screen Display
		Geman	Geman On Screen Display
Italian		Italian On Screen Display	
Spanish		Spanish On Screen Display	
others			
		Off	

REFERENCE

MENU	SUBMENU	OPTIONS	DESCRIPTION
SCREEN	TV Type	4:3 PS	Set TV screen at 4:3 Pan Scan
		4:3 LB	Set TV at screen 4:3 Letter Box
		16:9	Set TV at screen 16:9
	Screen Saver	On	Set screen saver to ON or OFF.
		Off	
	TV System	NTSC	Output signal as NTSC
		PAL	Output signal as PAL
		AUTO	Output signal as per default of disc
	Video output	CVBS+S-Video	CVBS+S-Video output
	Brightness	Normal	Select normal, bright, or soft to personal preference.
		Bright	
		Soft	
	Contrast	-3	Select various levels to adjust the contrast according to personal preference.
-2			
-1			
0			
+1			
+2			
+3			
Audio Setup	Down mix	Lo/Ro	Left only/R27. 0.35pnd the bao f000 TD (56 nly/R27ihe)Tj57.588
		Lt/Rt	
CUSTOM	Parental Ctrl	1	No one under 8 admitted
		2	
		3	
		4	
		5	
		6	
		7	
		8	
	Password	Off	Input number by users to change password, default setting:8888
		Old	
		New	
	Style	Verify	Change the background of colour OSD
		Style 1	
		Style 2	
		Style 3	
Angle Mark	Style 4	Set the Angle mark to ON or OFF	
	On		
Default	Off	Return to factory setup	
	Read		

◆ Handling Precautions

Maintenance

Hold the disc by the edge so the surface will not be soiled with fingerprints. Fingerprints, dirt and scratches can cause skipping and distortion. Do not use record cleaning sprays, benzene, thinner. Static electricity prevention liquids or any other solvent. Be careful not to drop or bend the disc. Do not try to close the disc tray when disc is not installed properly. Be sure to store the disc in its exclusive case when not in use.

Handling

Wipe gently with a soft, damp (water only) cloth. Move the cloth from the centre hole towards the outer edge. Improper disc storage: Discs may be damaged if they are stored in the following places: Areas exposed to direct sunlight; Humid or dusty areas; Areas directly exposed to a heat outlet or heating appliance.

◆ Player Maintenance

Be sure to turn the unit off and disconnect the AC power cord before maintaining the unit. Keep the unit clean. If the surfaces are extremely dirty, wipe the unit with a dry soft cloth. Never use alcohol, benzene or other chemicals. Do not use compressed air to remove dust. Ask the technician to maintain the unit when trouble happens.

REFERENCE

◆ Definition of terms

Angle

Recorded onto some DVD discs are scenes which have been simultaneously shot from a number of different angles (i.e. The same scene is shot from the front, left side and right side etc.). With such discs, the ANGLE button can be used to view the scene from different angles.

Chapter Number

These numbers are recorded on DVD discs, A title is subdivided into many sections. Each of them is number and specific parts of video presentations can be searched quickly using these numbers.

DVD disc

This refers to a high-density optical disc on which high quality pictures and sound have been recorded by means of digital signals. Incorporating a new video compression technology (MPEG2) and high-density recording technology, DVD enables full-motion video to be recorded over long periods of time (for instance, a whole movie can be recorded).

Subtitles

These are the printed lines appearing at the bottom of the screen which translate or transcribe the dialogue. They are recorded on DVD discs and up to 32 languages.

PBC

The language indicates on TV screen to imply operation or disc information.

Audio

Language recorded on discs and the maximum languages are up to 8.

Time

This indicates the play time elapsed from the start of a disc or a title. It can be used to find a specific scene quickly (it may not work with some discs).

Title Number

These numbers are recorded on DVD discs. When a disc contains two or more movies, these movies are numbered as title 1, title 2, etc.

Track Number

These numbers are assigned to the tracks which are recorded on audio CDs. They enable specific tracks to be located quickly. RAW The original DTS, AC-3 signals non-decoded. If users choose RAW as audio setting, they must connect a decoder to decode those original audio signals.

SPECIFICATIONS

Power requirement:	AC 120V~60Hz
Power consumption:	15W
Signal system:	NTSC/PAL/AUTO
Dimension:	260mm x 38mm x 260mm

Disc played:

- | | |
|-----------------------------------|-------------|
| 1. DVD-video disc | 2. CD disc |
| ● 12cm single-sided, single-layer | ● 12cm disc |
| ● 12cm single-sided, double-layer | ● 8cm disc |
| ● 12cm double-sided, double-layer | |
| ● 8cm single-sided, single-layer | |
| ● 8cm single-sided, double-layer | |
| ● 8cm double-sided, double-layer | |

Video output

- Output level: 1±0.2Vp-p (75 ohm)
- Horizontal resolution: >500 lines
- S/N ratio: >60dB

Audio output (Impedance: 10k ohm):

- Output level: 1.8±0.2/-0.8Vrms (1KHz 0dB)
- Harmonic distortion: <0.01% (JIS-A 1KHz, typical)
- Dynamic range: >80dB (JIS-A 1KHz, typical)
- S/N ratio: 90dB (JIS-A 1KHz, typical)

Weight and dimensions are approximate. Specifications are subject to change with or without notice.

